

Silicon Tuning Diode

This device is designed for FM tuning, general frequency control and tuning, or any top-of-the-line application requiring back-to-back diode configurations for minimum signal distortion and detuning.

- High Figure of Merit — $Q = 140$ (Typ) @ $V_R = 3.0$ Vdc, $f = 100$ MHz
- Guaranteed Capacitance Range
37–42 pF @ $V_R = 3.0$ Vdc (MV104)
- Dual Diodes – Save Space and Reduce Cost
- Monolithic Chip Provides Near Perfect Matching – Guaranteed $\pm 1.0\%$ (Max) Over Specified Tuning Range

MV104

**DUAL
VOLTAGE VARIABLE
CAPACITANCE DIODE**

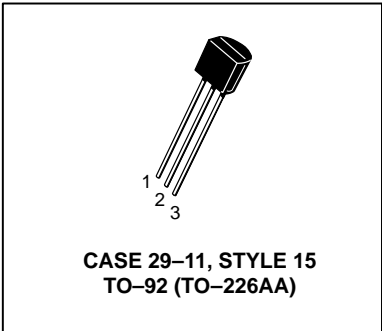

MAXIMUM RATINGS (EACH DIODE)

Rating	Symbol	Value	Unit
Reverse Voltage	V_R	32	Vdc
Forward Current	I_F	200	mAdc
Total Power Dissipation @ $T_A = 25^\circ\text{C}$ Derate above 25°C	P_D	280 2.8	mW mW/°C
Junction Temperature	T_J	+125	°C
Storage Temperature Range	T_{stg}	-55 to +150	°C

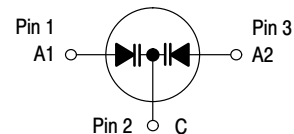

ELECTRICAL CHARACTERISTICS ($T_A = 25^\circ\text{C}$ unless otherwise noted) (EACH DIODE)

Characteristic	Symbol	Min	Typ	Max	Unit
Reverse Breakdown Voltage ($I_R = 10 \mu\text{Adc}$)	$V_{(BR)R}$	32	—	—	Vdc
Reverse Voltage Leakage Current $T_A = 25^\circ\text{C}$ ($V_R = 30$ Vdc) $T_A = 60^\circ\text{C}$	I_R	— —	— —	50 500	nAdc
Diode Capacitance Temperature Coefficient ($V_R = 4.0$ Vdc, $f = 1.0$ MHz)	TC_C	—	280	—	ppm/°C

Device	C_T , Diode Capacitance $V_R = 3.0$ Vdc, $f = 1.0$ MHz pF		Q , Figure of Merit $V_R = 3.0$ Vdc $f = 100$ MHz		C_R , Capacitance Ratio C_3/C_{30} $f = 1.0$ MHz	
	Min	Max	Min	Typ	Min	Max
MV104	37	42	100	140	2.5	2.8

MV104

TYPICAL CHARACTERISTICS (Each Diode)

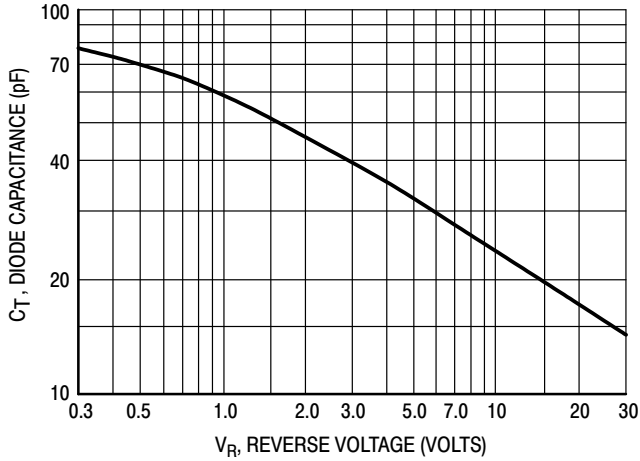

Figure 1. Diode Capacitance (Each Diode)

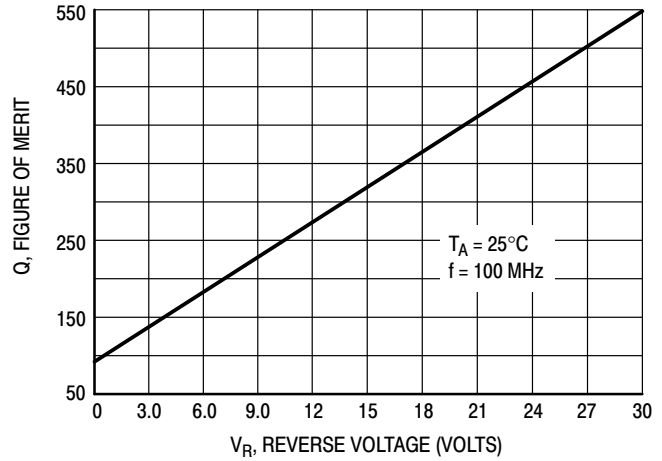

Figure 2. Figure of Merit versus Voltage

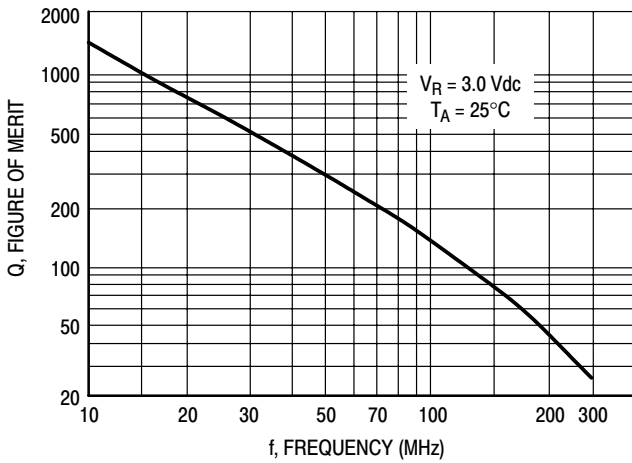

Figure 3. Figure of Merit versus Frequency

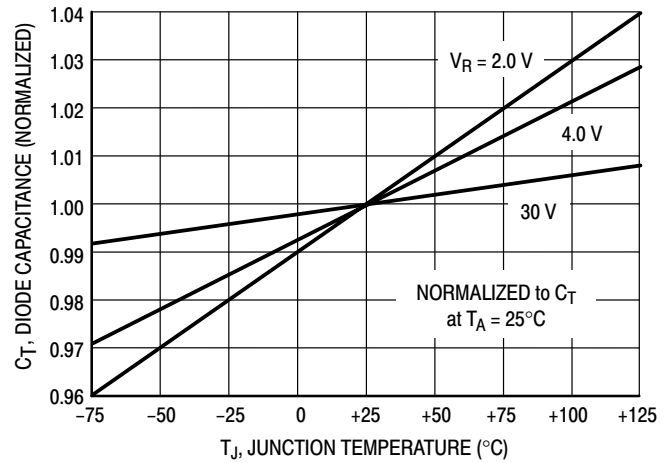

Figure 4. Diode Capacitance versus Temperature

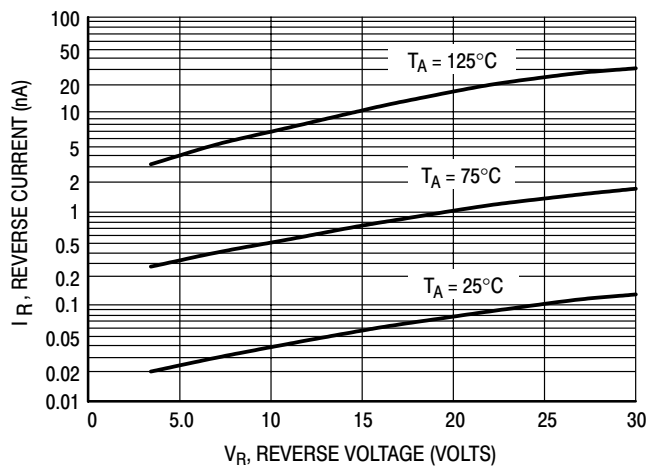
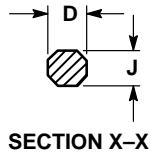
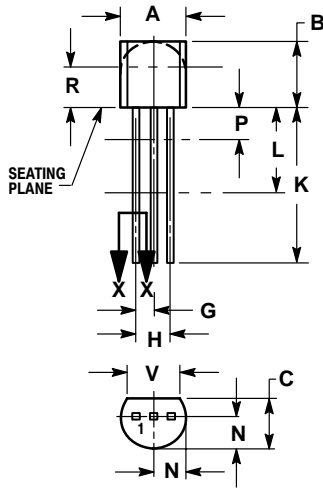

Figure 5. Reverse Current versus Reverse Voltage

MV104

PACKAGE DIMENSIONS

TO-92 (TO-226AA) CASE 29-11 ISSUE AL



YLE 15:
PIN 1. ANODE 1
2. CATHODE
3. ANODE 2

NOTES:

1. DIMENSIONING AND TOLERANCING PER ANSI Y14.5M, 1982.
2. CONTROLLING DIMENSION: INCH.
3. CONTOUR OF PACKAGE BEYOND DIMENSION R IS UNCONTROLLED.
4. LEAD DIMENSION IS UNCONTROLLED IN P AND BEYOND DIMENSION K MINIMUM.

DIM	INCHES		MILLIMETERS	
	MIN	MAX	MIN	MAX
A	0.175	0.205	4.45	5.20
B	0.170	0.210	4.32	5.33
C	0.125	0.165	3.18	4.19
D	0.016	0.021	0.407	0.533
G	0.045	0.055	1.15	1.39
H	0.095	0.105	2.42	2.66
J	0.015	0.020	0.39	0.50
K	0.500	---	12.70	---
L	0.250	---	6.35	---
N	0.080	0.105	2.04	2.66
P	---	0.100	---	2.54
R	0.115	---	2.93	---
V	0.135	---	3.43	---

ON Semiconductor and  are trademarks of Semiconductor Components Industries, LLC (SCILLC). SCILLC reserves the right to make changes without further notice to any products herein. SCILLC makes no warranty, representation or guarantee regarding the suitability of its products for any particular purpose, nor does SCILLC assume any liability arising out of the application or use of any product or circuit, and specifically disclaims any and all liability, including without limitation special, consequential or incidental damages. "Typical" parameters which may be provided in SCILLC data sheets and/or specifications can and do vary in different applications and actual performance may vary over time. All operating parameters, including "Typicals" must be validated for each customer application by customer's technical experts. SCILLC does not convey any license under its patent rights nor the rights of others. SCILLC products are not designed, intended, or authorized for use as components in systems intended for surgical implant into the body, or other applications intended to support or sustain life, or for any other application in which the failure of the SCILLC product could create a situation where personal injury or death may occur. Should Buyer purchase or use SCILLC products for any such unintended or unauthorized application, Buyer shall indemnify and hold SCILLC and its officers, employees, subsidiaries, affiliates, and distributors harmless against all claims, costs, damages, and expenses, and reasonable attorney fees arising out of, directly or indirectly, any claim of personal injury or death associated with such unintended or unauthorized use, even if such claim alleges that SCILLC was negligent regarding the design or manufacture of the part. SCILLC is an Equal Opportunity/Affirmative Action Employer.

PUBLICATION ORDERING INFORMATION

NORTH AMERICA Literature Fulfillment:

Literature Distribution Center for ON Semiconductor
P.O. Box 5163, Denver, Colorado 80217 USA
Phone: 303-675-2175 or 800-344-3860 Toll Free USA/Canada
Fax: 303-675-2176 or 800-344-3867 Toll Free USA/Canada
Email: ONlit@hibbertco.com
Fax Response Line: 303-675-2167 or 800-344-3810 Toll Free USA/Canada

N. American Technical Support: 800-282-9855 Toll Free USA/Canada

EUROPE: LDC for ON Semiconductor – European Support

German Phone: (+1) 303-308-7140 (Mon-Fri 2:30pm to 7:00pm CET)
Email: ONlit-german@hibbertco.com
French Phone: (+1) 303-308-7141 (Mon-Fri 2:00pm to 7:00pm CET)
Email: ONlit-french@hibbertco.com
English Phone: (+1) 303-308-7142 (Mon-Fri 12:00pm to 5:00pm GMT)
Email: ONlit@hibbertco.com

EUROPEAN TOLL-FREE ACCESS*: 00-800-4422-3781

*Available from Germany, France, Italy, UK, Ireland

CENTRAL/SOUTH AMERICA:

Spanish Phone: 303-308-7143 (Mon-Fri 8:00am to 5:00pm MST)
Email: ONlit-spanish@hibbertco.com
Toll-Free from Mexico: Dial 01-800-288-2872 for Access –
then Dial 866-297-9322

ASIA/PACIFIC: LDC for ON Semiconductor – Asia Support

Phone: 1-303-675-2121 (Tue-Fri 9:00am to 1:00pm, Hong Kong Time)
Toll Free from Hong Kong & Singapore:
001-800-4422-3781
Email: ONlit-asia@hibbertco.com

JAPAN: ON Semiconductor, Japan Customer Focus Center

4-32-1 Nishi-Gotanda, Shinagawa-ku, Tokyo, Japan 141-0031
Phone: 81-3-5740-2700
Email: r14525@onsemi.com

ON Semiconductor Website: <http://onsemi.com>

For additional information, please contact your local Sales Representative.